

akeron



THE

LITTER BIN & ASHTRAY

CATALOGUE

Introduction

Litter bins - Ashtrays - Metal fabrications

Equipment for safety and cleanliness is most likely a priority consideration in many businesses and other places where people forgather for entertainment and leisure or just pass through. Many men and women enjoy their cigarette, cigar or pipe, and some are not always careful with the ash and ends.

At Akeron we have made it our concern to design attractive and safe ashtrays. This catalogue describes a variety of routine production models, although designs and features to customers specifications are frequently undertaken.

May we draw your attention to Model No. 58 for mounting on to wall or seat backs and the combined Litter-bin / Ashtray Model No. 13 designed for integration into public areas, lounges, licensed premises and dining rooms. Model No. 7 suitable for landings and passageways, attractively finished in black and chrome or other colour finishes.

An interesting, fairly recent addition to our collection is the versatile Model No.24 cylindrical upright bin. Selections can be made from six variants of this 24" x 9" diameter model by subtraction of certain components according to requirements. Basically the model No. 24 is a straight forward litter bin. Add an ashtray section a few inches under the top cover and it serves the dual ashtray / waste bin function. Add one of two different anti-fire devices and this will secure the bin and its immediate surroundings from ravages of accidental fire that might develop from someone throwing a cigarette end into the rubbish section of the bin by mistake.

Perhaps the safest of all ashtrays is Model No.59P 'Honeycomb' style table ashtray (in either high grade plastic or chrome) improves the safety level of any environment in which it may be placed : in passenger, freight and tanker vessels, as well as in the accommodation units of off-shore oil rigs, offices, places of entertainment and leisure, restaurants and pubs.

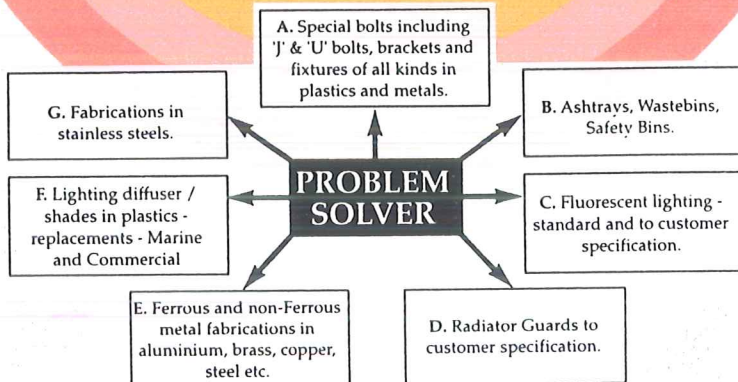

Safety Wall Ashtrays

Post your cigarette before entering

MODEL 75

The new style safety ashtray bin incorporating the easy to empty and clean waste tray. this bin has been designed for exterior wall mounting at 'strategic' positions of a factory and business premises. To Enable staff and visitors to cease smoking and dispose of their part smoked cigarette safely before making an entrance. In this way the bin takes in a form of waste which would otherwise, most likely be thrown to the ground presenting an irritating untidiness at entrances.

- * A discreet size and attractive design.
- * An internal 'suffocating' flap to exclude air thus ensuring safety against fire.
- * Internal swivel action tray for easy emptying and cleaning.
- * Stainless steel or mild steel powder coated for a durability and appearance in all weather conditions.
- * Also can be supplied to customers specified dimensions.

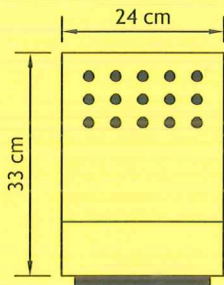
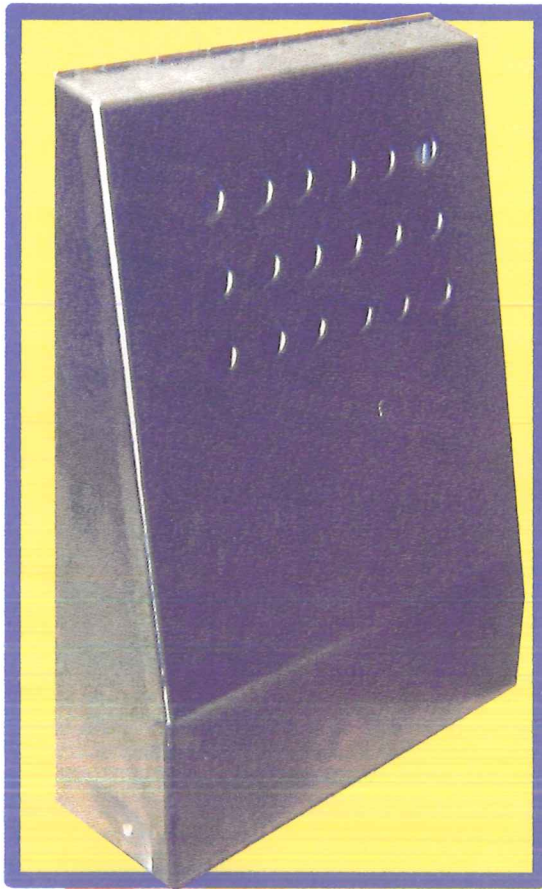

Front panel lifting bar to expose interior

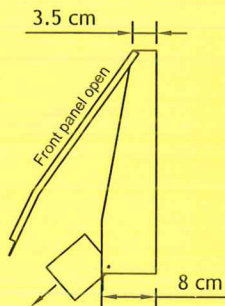

Side view showing the internal cigarette collection tray in emptying mode

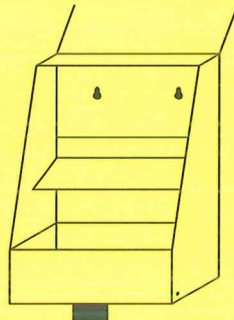

Front panel opened up showing cigarette collection tray & air restrictor

Safety free standing Ashtrays

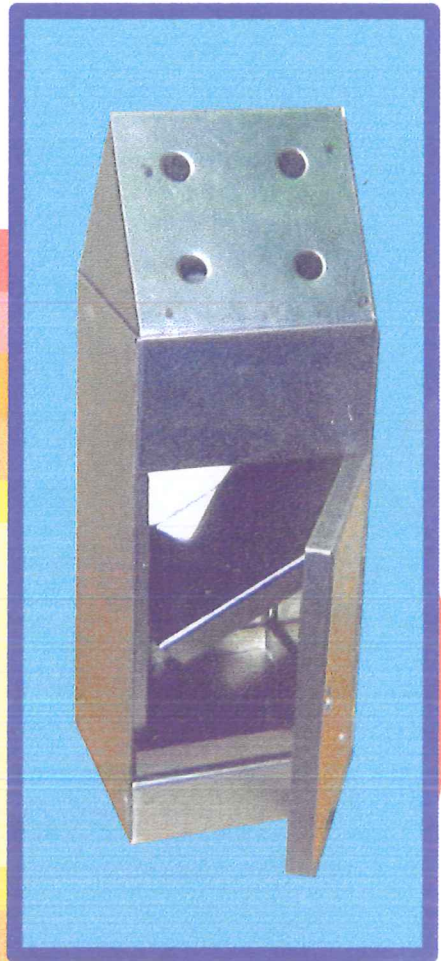
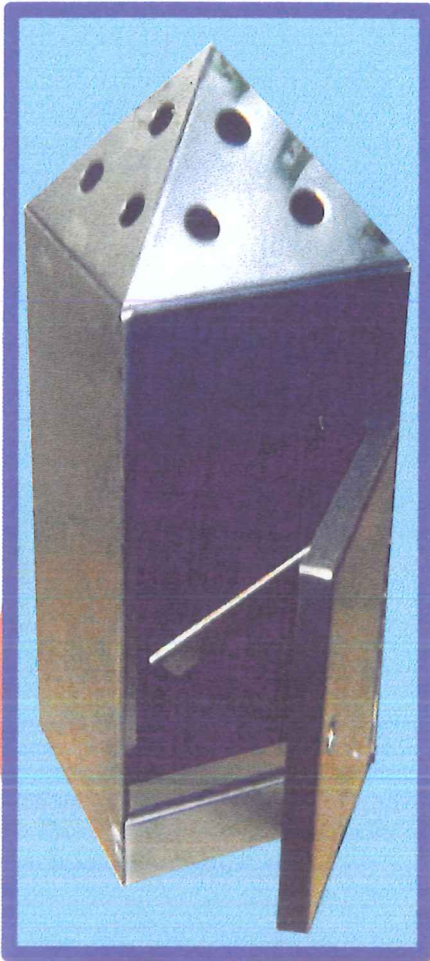

MODEL 76

Designed with the 'conical' head is a variant of the Akeron square section and cylindrical ashtray/waste bin free standing floor models for passageways and corridors. For a number of interior locations as required in hotels, leisure complexes, offices, factories and many other locations where people forgather and pass through. The waste tray is positioned at the base of the square section body. For emptying and cleaning the waste tray can be removed and replaced easily by opening a door at the rear of the bin. Both models can be supplied in stainless steel or mild steel powder coated. In both cases ensuring durability and an attractive appearance. Body 5" square, box section 33" high & 'conical' 4" high. Also can be supplied to customers specified dimensions.

Versatile Ashtray/Waste Bins

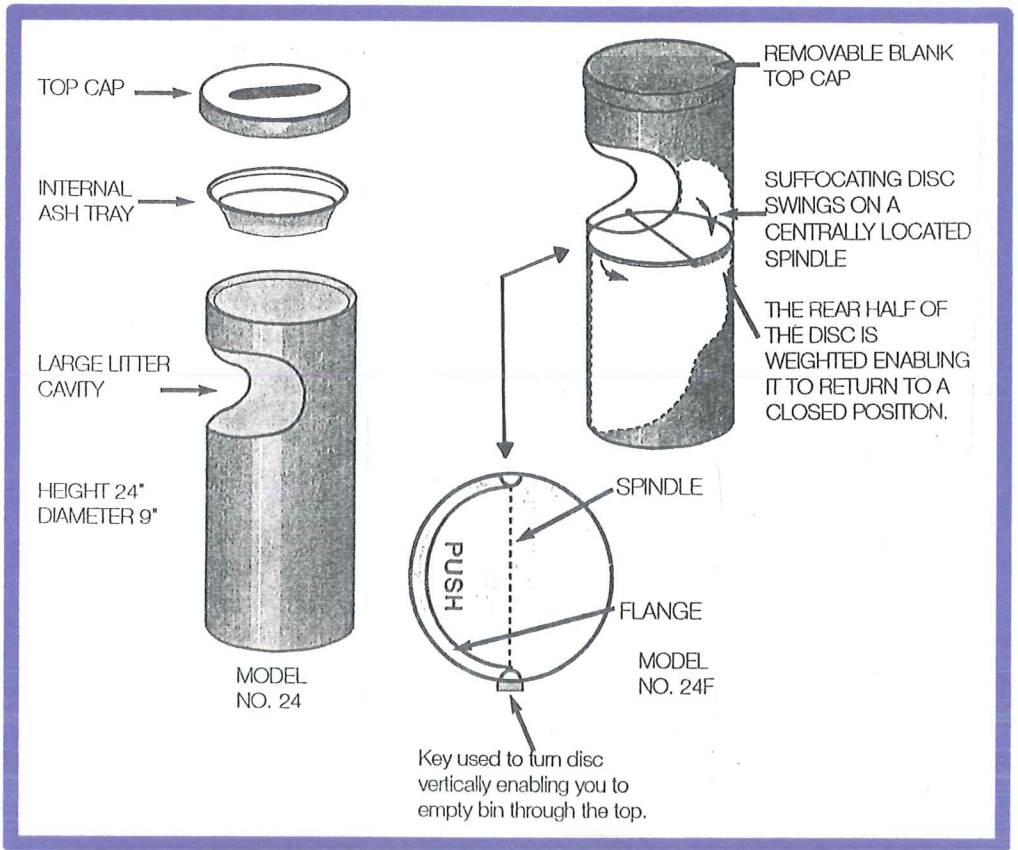

MODEL 24

Quite without thinking a person could throw a smouldering cigarette end into a bin intended for LITTER ONLY - thinking the cigarette end is 'dead'. According to the position of the bin any fire that might occur from a smouldering 'end' in contact with dry paper rubbish might have more serious consequences than just a fire in a bin. For example if the bin is positioned in a clear space the rubbish could burn out without problems, but should the bin be close to a wall, (especially one on which notice boards are fixed), shelves, a desk, or factory bench for example, it could be the start of a major destructive fire.

The basic Model No. 24 cylindrical bin is convertible from a Litter Bin ONLY (No. 24LO) to an Ashtray/Litter Bin (24AL) or in each case to either of the following to include a Fire Resistant mechanism - Models No. 24LOF or Model 24ALF suffixed by / S or / T to determine type of anti-fire device.

Waste Bin

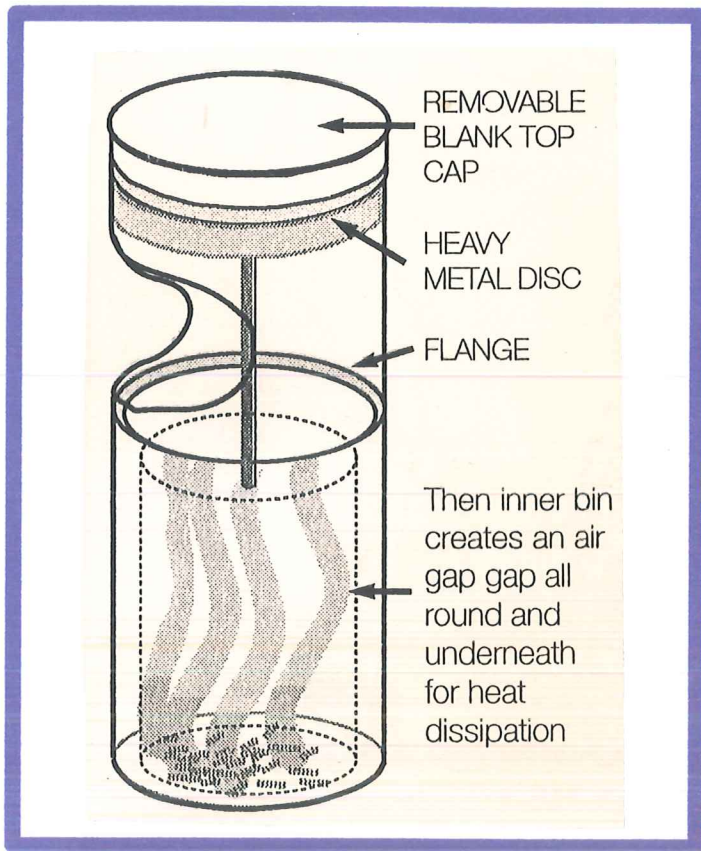

**Fire
Resistant
Litter Bin**
With fire
'Suffocating Disc'
Or with 'Thermal
Reaction device'

MODEL 24 series cylindrical bins

The model number 25 LITTER BIN uses the same cylindrical body as the Akeron 24F fire resistant LITTER BIN incorporating the 'suffocation disc' anti-fire mechanism. In this model (24F) it is a case of 'prevention is better than cure'.

A different, but nevertheless effective method is employed in Model 24 fire resistant LITTER BIN. In this case a fire must occur first. The heat generated will then activate a thermal device causing the release of a heavy metal disc to fall upon a flange surrounding the interior of the bin thus sealing the fire from the outside air.

After operation the thermal device has to be replaced and the disc cleaned and re-set.

Waste Bins / Ashtrays

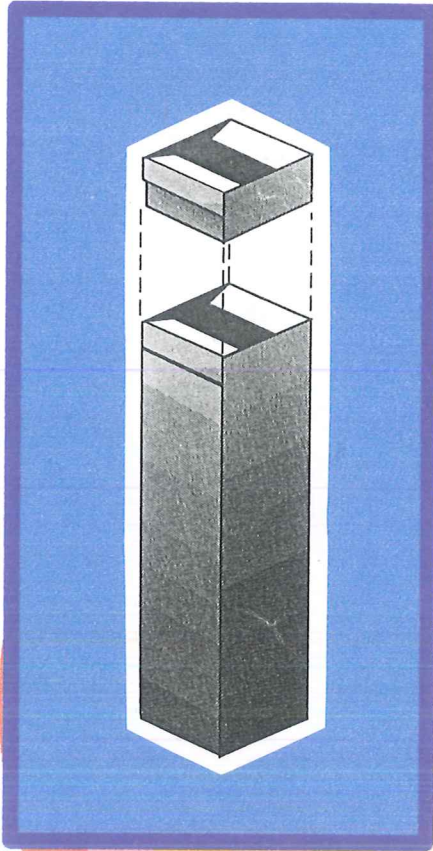

MODEL 7

A smart square section waste bin / ash bin with detachable bright stainless steel ashtray as top.

Dimensions : 21" x 6" x 6"

Finishes : Body made from mild steel powder coated

Black.

MODEL 13

Combined round litter bin and Ashtray. Size 10" x 23" 1/2

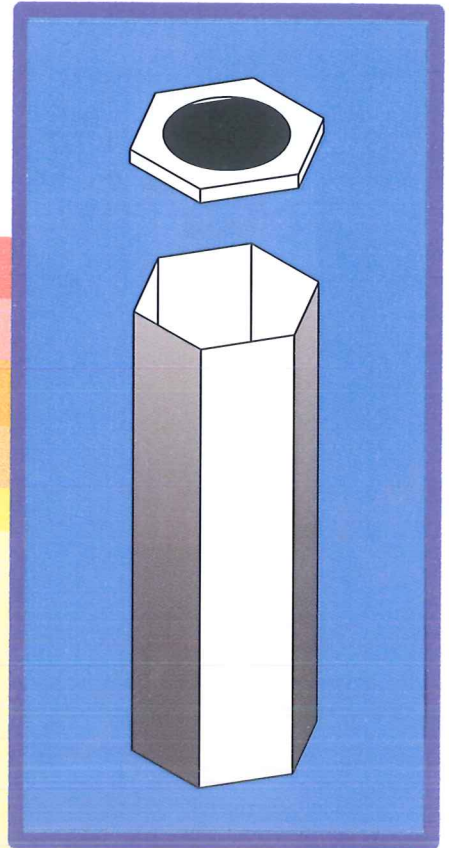

MODEL 69

The new hexagonal waste bin / ashtray made from stainless steel for interior and exterior surface siting. Although the standard size is 22" high x 8" wide - more appropriate for office use - a larger model for factory & warehouse can be made to customers order.

Smart & Durable

Waste Bins

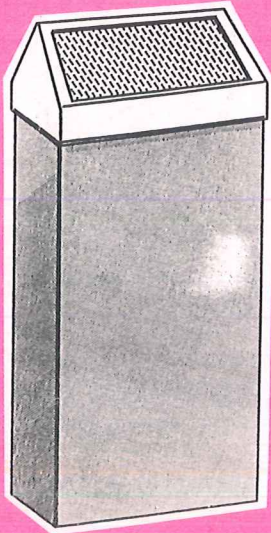

MODEL 11

Swing top rectangular litter bin with removable lining for easy emptying.

Dimensions :

28 1/2" x 15" x 8"

Finishes :

Available in Black with Chrome / Stainless Steel top.

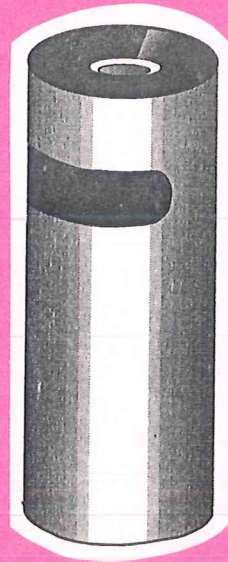

MODEL 9

Popular attractively designed substantial round litter bin.

Dimensions : 6" x 10" / 6" x 16" / 6" x 22"

Finishes : Available in Black, Bronze or Silver Grey with Chrome top.

MODEL 14

Cylinder litter bin. Size 14" x 32" and 12" x 30" All round litter bins available in Black, Bronze or Silver Grey with Chrome top.

The Akeron cork catcher

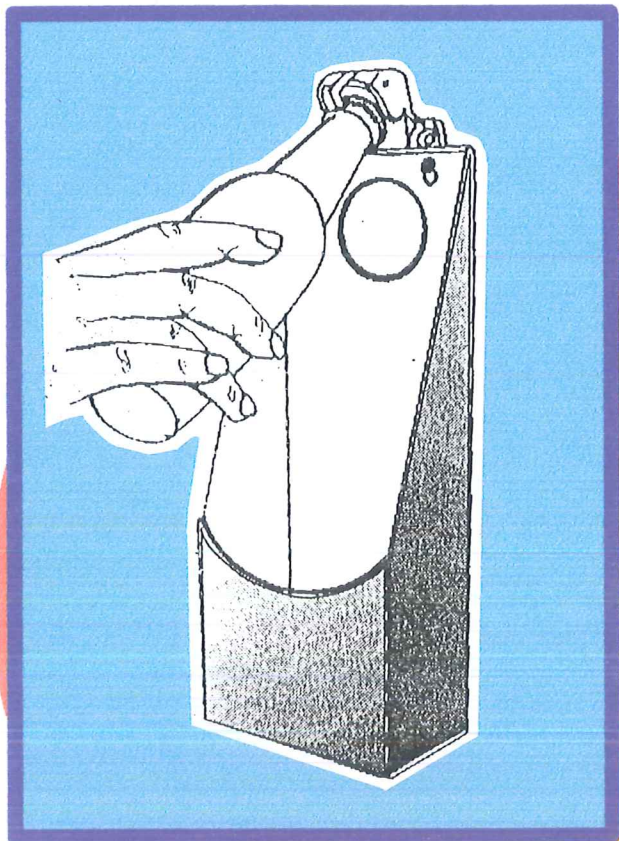

Pillar & Undercounter

Shown here is our vertical pillar type of catcher. An extremely useful addition to any busy bar, hotel or club etc. Available in metal: Bronze or Grey hammered finish or in strong moulded plastic. Both types of catchers are non chip and impervious to moisture.

Plastic swivel bottle
opener also available

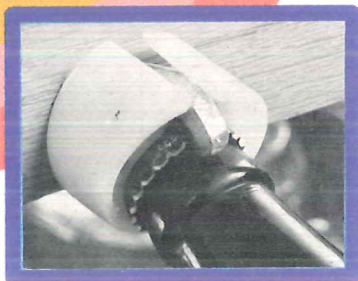

Ashtray cleaner

For the safe clearance of cigarette ends and small waste from table and bar top ashtrays.

A modern well constructed safety bin designed to make your customers or visitors less dangerous and your property safer.

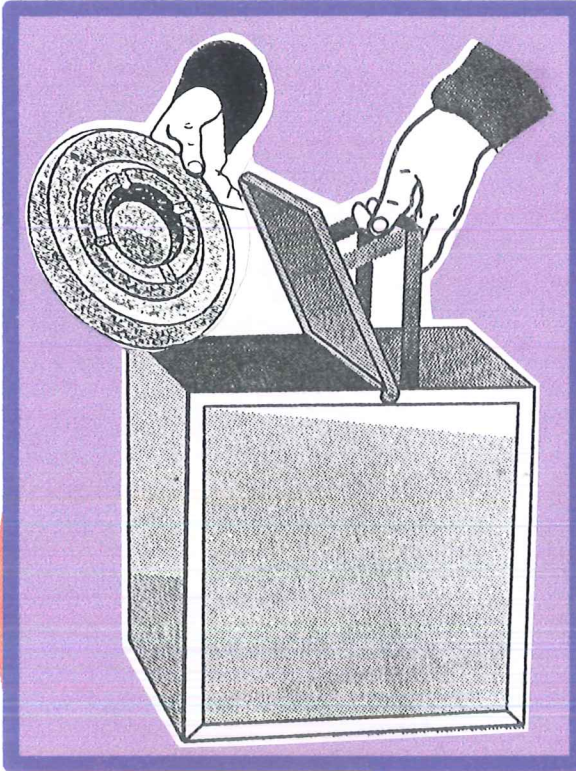

MODEL 5L SAFETY BIN

Overall dimensions
10" x 10" x 10"

For Hotels, Licensed premises, Leisure centres, Restaurants etc.

Made from steel and finished in hammered grey, gold or red. Used extensively by public authorities, commercial organisations, leisure complexes, exhibitions and places of entertainment.

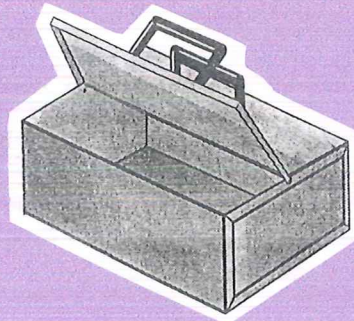

MODEL 5 SAFETY BIN

Overall dimensions
11" x 8" x 8"

Floor Ash Bins

- * REDUCE FIRE HAZARD * PROMOTE CLEANLINESS *
- PROTECT CARPETS & FLOORS
- * REDUCE CONTAMINATION TO INTERIOR DECOR

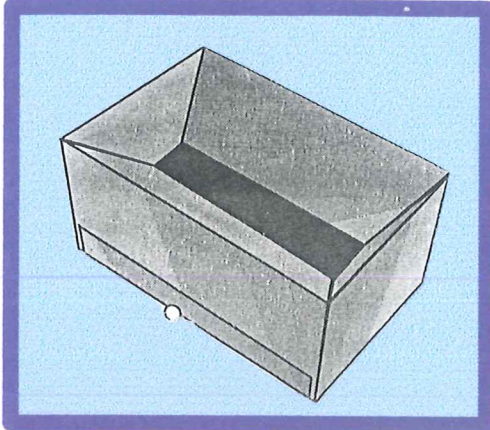

MODEL 1

Sturdy and practical design with pull out tray for ease of emptying.

Size 12" x 8 1/4" x 6 1/4"

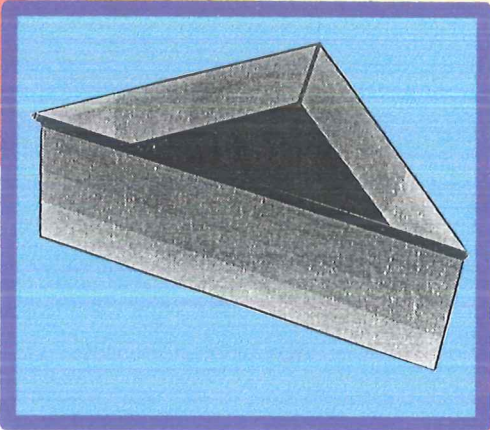

MODEL 6

Discreet corner ashtray with detachable top.

Size 10" x 10" x 14 1/2"

Shown here are three types of our popular and well designed floor ash bins, available in a range of finishes to suit your requirements.

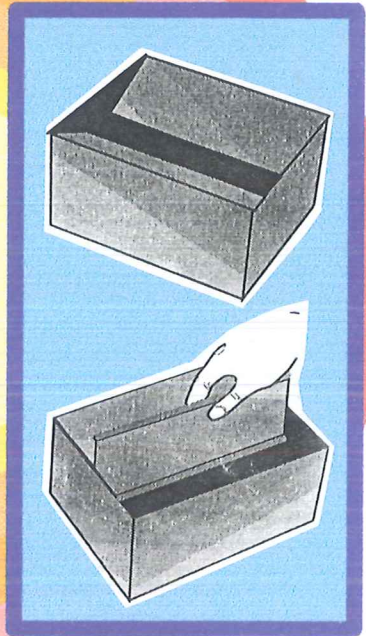

MODEL 3

A practical and easily maintained design with hinged flats. Simple to empty and clean.

Size 10 3/4" x 8 3/4" x 5"

Floor Ash Bins

Akeron.....quality, safety and value built in.

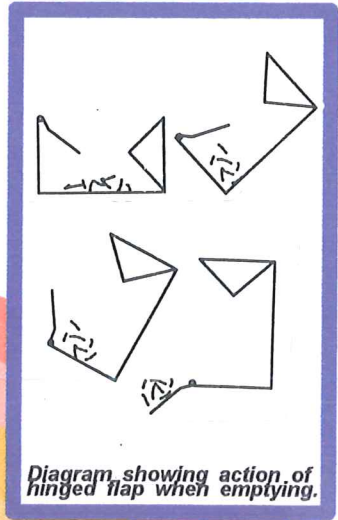
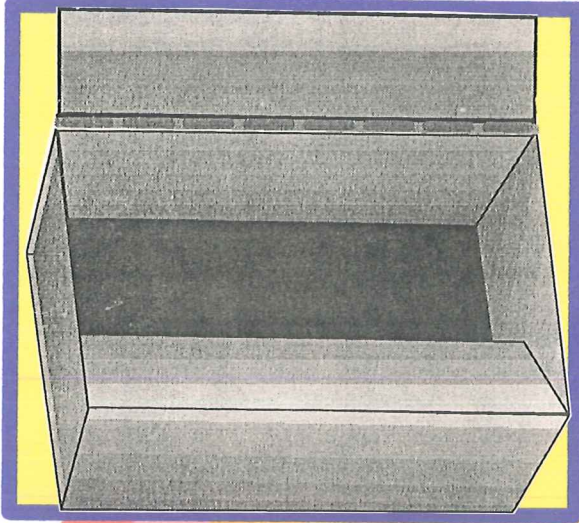

Diagram showing action of hinged flap when emptying.

MODEL 23

This is a new design incorporating a hinged flap, enabling more convenient and trouble free emptying. An effective safety floor ashtray well known nation-wide for reducing fire risks in a various work and leisure environment. A time saving and novel feature of this model is the hinged interior section. The hand fits neatly under the fixed section and when lifted the ashtray automatically tilts downwards allowing the hinged flap to fall down and the contents to empty.

Finished in Bronze, Black, Grey or Red.

Swing action Waste Control Bin

MODEL 72

Designed principally for industrial waste control. Wall-mounted, swivel action container for easy emptying & cleaning without detaching complete assembly. It can be made to suit many different situations and premises and manufactured in specified sizes and materials for interior or exterior mounting. Materials can be mild steel, powder coated, galvanised steel or stainless steel. Colour to match decor can also be specified within a certain range. Essentially an industrial waste bin with sizes up to 24" back plate mounting length, a smaller version from 10" is intended for domestic use and in kitchens.

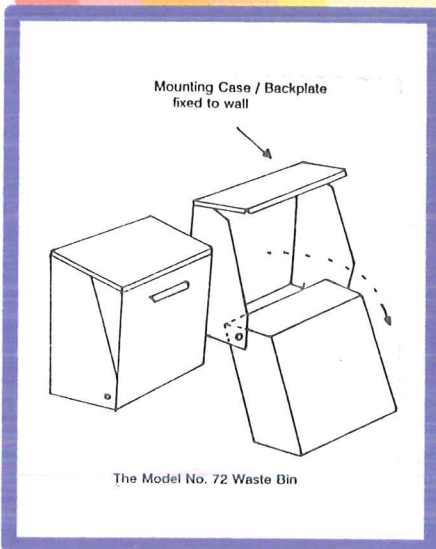

Wall & Pillar Ashtrays

For people who enjoy smoking in all the places where people gather for entertainment, leisure and work. * REDUCE FIRE HAZARD * PROTECTION TO CARPETS & FLOORS * PROMOTES CLEANLINESS * REDUCES CONTAMINATION OF INTERIOR DECORATION * EASY TO CLEAN

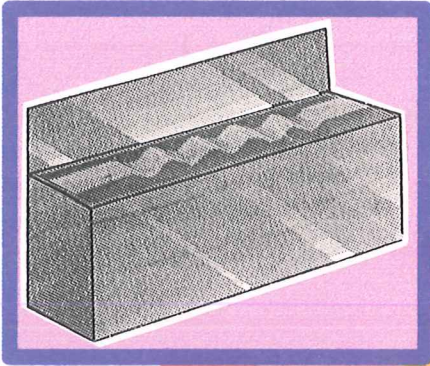

MODEL 46 6" x 3" x 3"

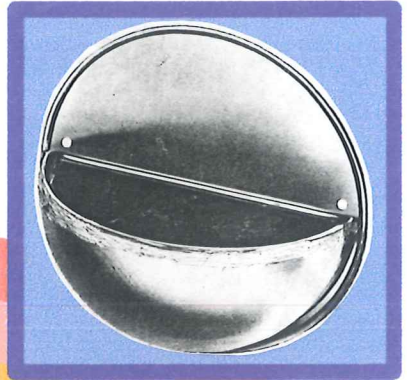

MODEL W/B/42
Wall ball ashtray with detachable lining. Size 6" x 6" x 3"

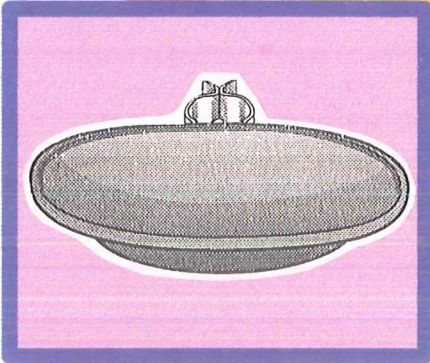

MODEL W/SC/57 With spring clip.
Size 4" x 2"



MODEL 47 Thief proof, Pivot safety ashtray in stainless steel.
Size 3" x 4" x 2"

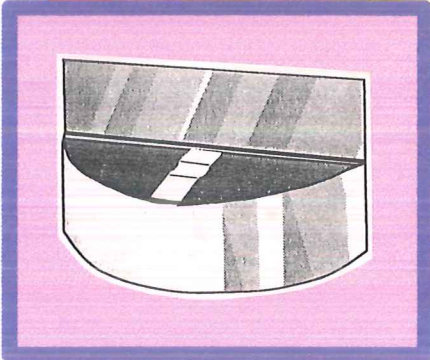

MODEL 58 Wall Ashtray. Sizes :
12" x 6" x 4". 8" x 4" x 3".
6" x 3" x 2"

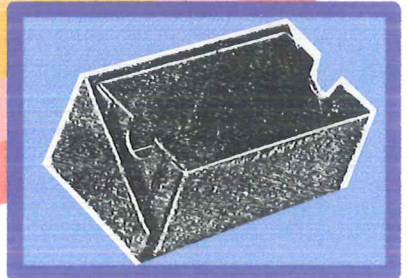

MODEL 62 Ashtray and bracket
Size 4" x 2" x 2"

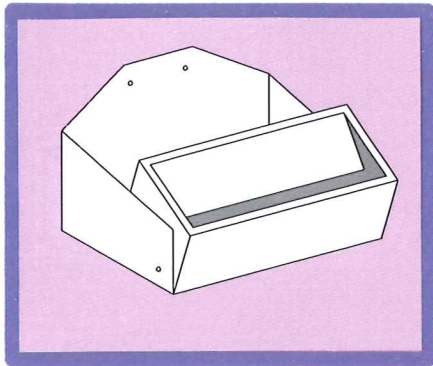

MODEL 70

The ashtray illustrated showing partial swivel forward with safety lid pressed down. Size 5"-6" x 2 1/2" / 3 1/2" x 2 1/2" / 3 1/2"



MODEL W/SWO/54

Swivel oblong pivot ashtray for easy emptying. A strong design also available in larger sizes. Size: length 4", depth 1 1/4", width 2"

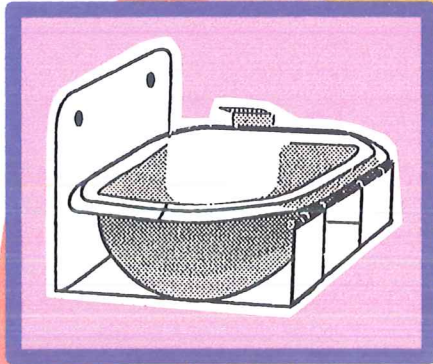

MODEL W/H/50

Hinged tip up. Size 4" x 1 1/2"

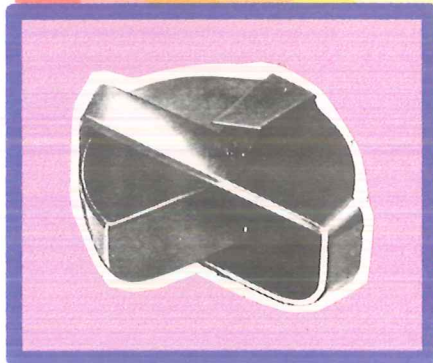

MODEL W/AC/56 Simple swivel type smartly mounted with inner tray, for armchairs.

Ashtrays A must for Fire Insurance

* Prevent the risk of fire * No more lingering smells of smouldering cigarette ends *
Designed for Safety & Durability * Tested by the British Safety council. The Akeron
safety ashtrays are already in use in thousands of homes, hotels, ships, public
buildings and tanker fleets.

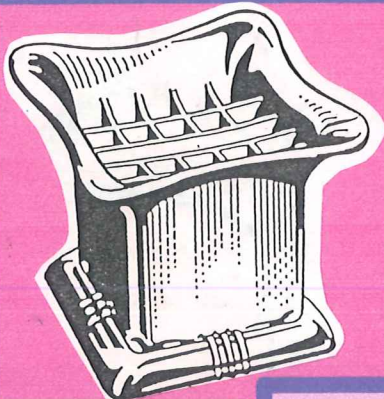

MODEL HC59M

Produced in a hard wearing alloy with a chrome finish. A detachable honeycomb insert incorporating a match holder. Detachable base for easy cleaning and rubber mounts giving an excellent grip on any surface.

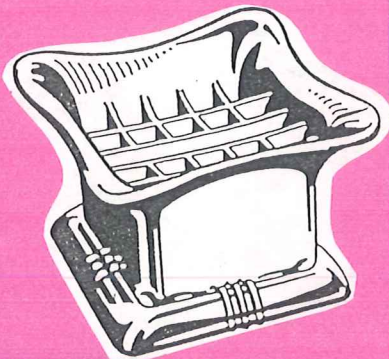

MODEL HC59P

Produced in a high grade plastic with detachable base easy cleaning. Available in Black or Walnut.

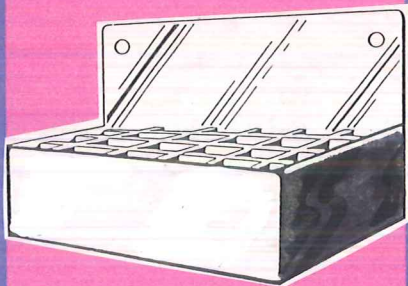
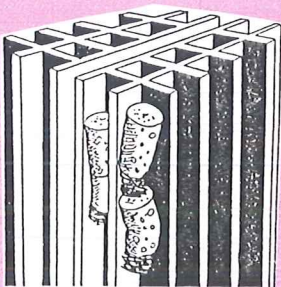

MODEL HC59W

This wall mounted model is ideal for public buildings, toilets, ships etc. Produced from sheet metal in various finishes.

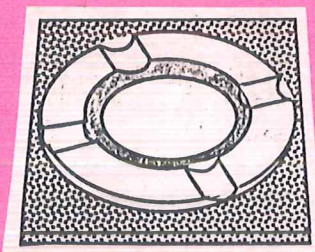

MODE 90

Practical, simple and inexpensive, round flat style.

Waste Paper Bins

Akeron offer a wide range of waste paper bins in a variety of styles to suit all requirements

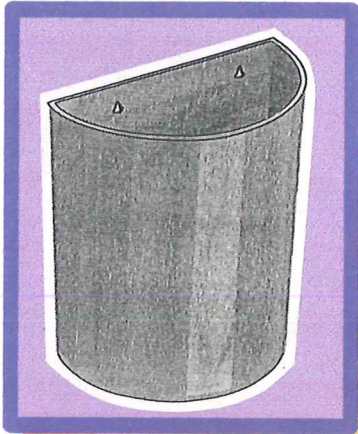

HALF ROUND WASTE PAPER BIN

Made from steel 12" high,
12" wide, 6" back to front.
Grey hammer finish.

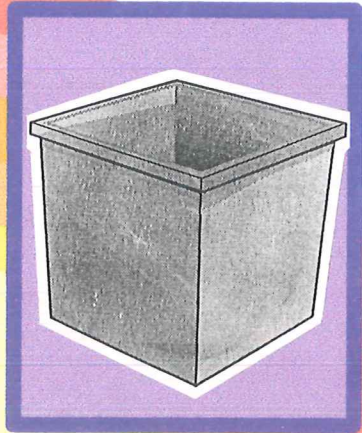

OFFICE TYPE SQUARE WASTE PAPER BIN

Made from steel 12" high,
12" square at top, 10"
square at bottom. In green
or grey.



ROUND WASTE PAPER BIN

9" high, in a wide range
of colours.

*Akeron
quality, safety and value built in.*

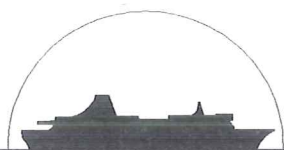
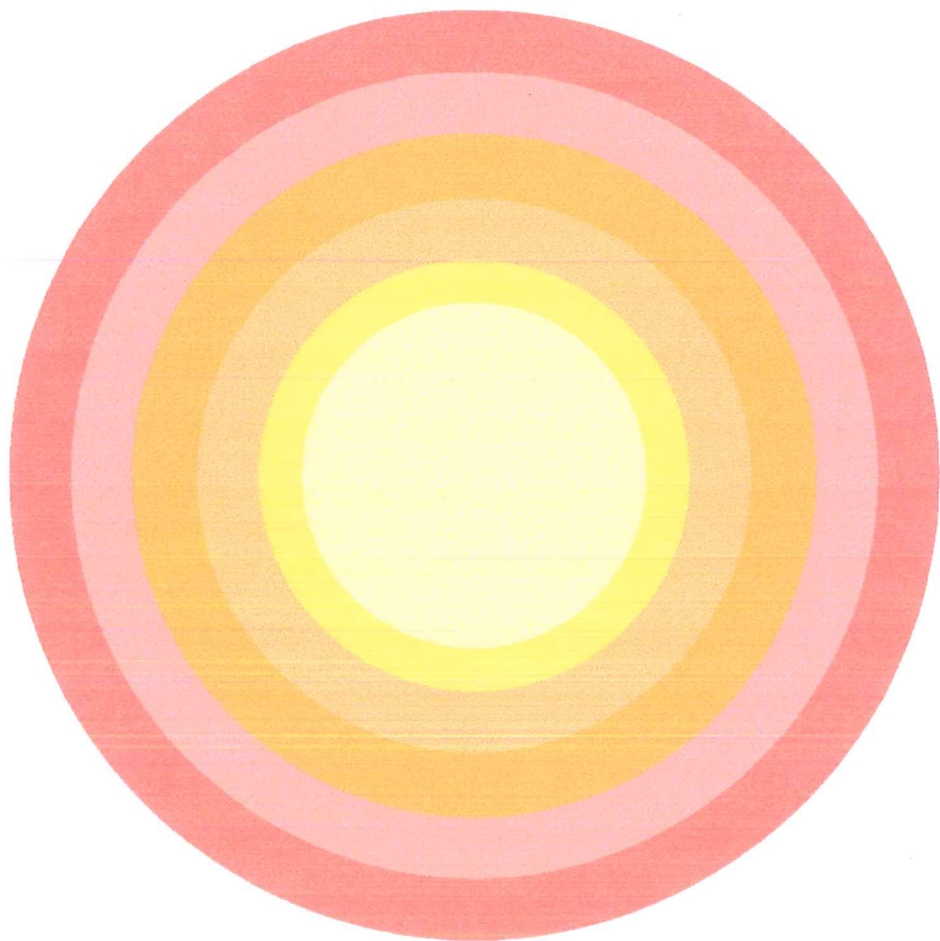

akeron

**AKERON (UK) LTD., 15 TERMINAL CLOSE,
SHOEBURYNESS, ESSEX. SS3 9BN. ENGLAND.**

**T: +44 (0) 1702 297101
E: akeron@talktalkbusiness.net**

**F: +44 (0) 1702 297101
W: www.akeron-uk.com**